



- INNOVATIVE
- CONVENIENT
- IMPERVIOUS
- STYLISH
- MODULAR

tei[®]
dental
passion for innovation

DENTAL
FURNITURE



Quick
simple
Customizable

Made of Stainless steel and powder Coating / Pu paint finish
Top is made of Corian / Tempered glass / Granite
Elegant handles



- Can be wall mount or floor mount
- Soft closing drawers
- Lockable caster wheel





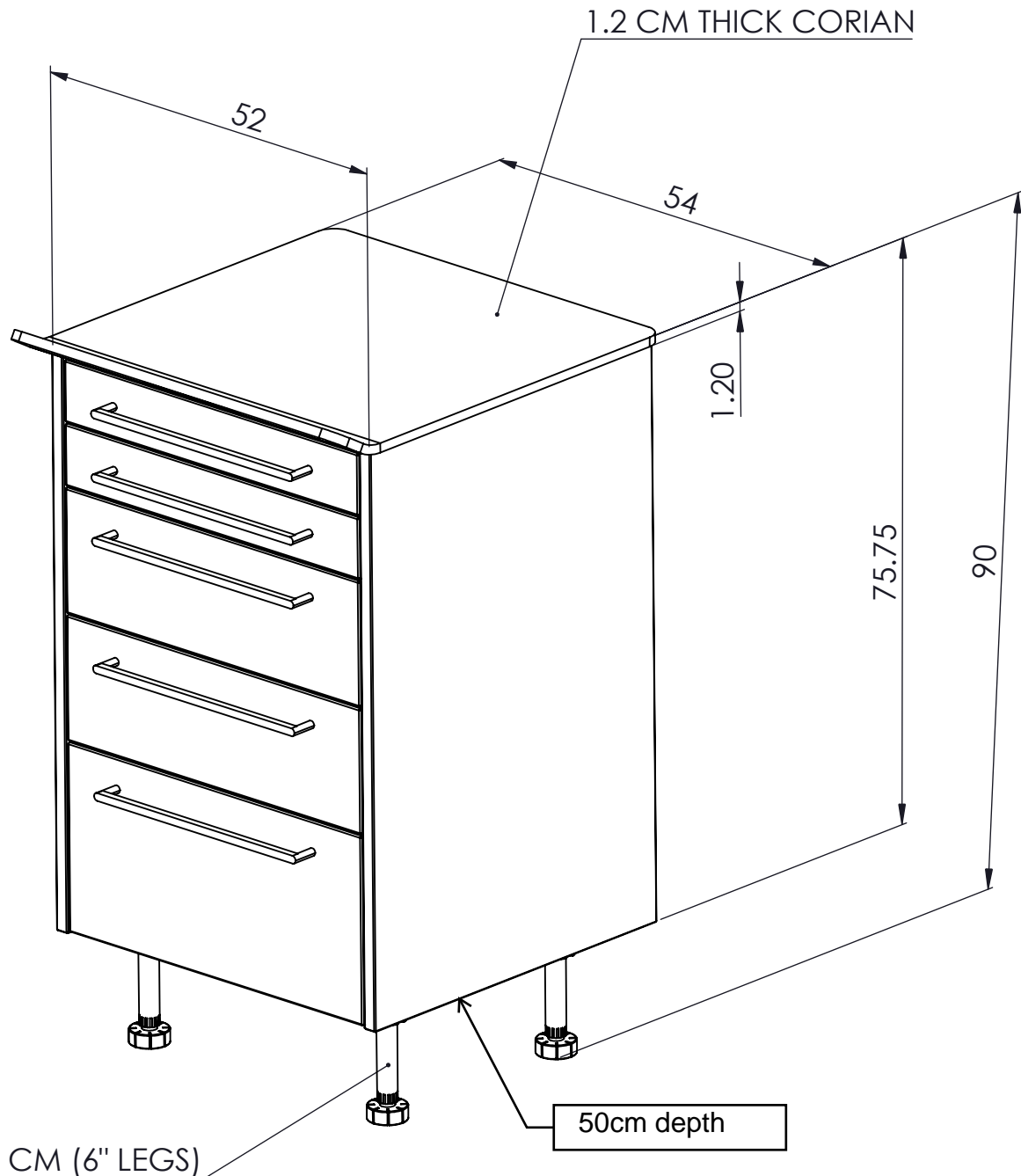

DRAWERS COMBINATION CAN BE SELECTED FROM MANUAL ACCORDINGLY.



2VS-2S-1M

5 Drawers

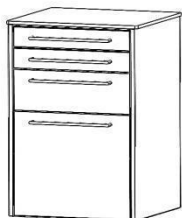

2VS-1S-1L

4 Drawers



3S-1M

4 Drawers

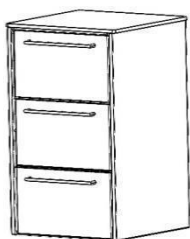

3M

3 Drawers



3VS-2M

5 Drawers



3VS-3S

6 Drawers

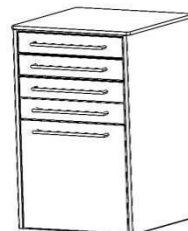

4VS-1L

5 Drawers

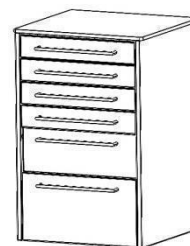

4VS-1S-1M

6 Drawers

Selection of combination of drawers:-

According to height (mm) of Drawers

VS = 80H S = 162H M = 244H L = 408H

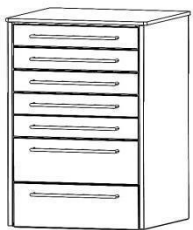

5VS-2S

7 Drawers



6VS-1M

7 Drawers

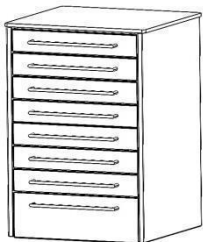

7VS-1S

8 Drawers

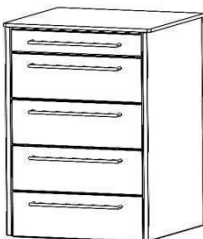

1VS-4S

5 Drawers



1VS-1M-1L

3 Drawers

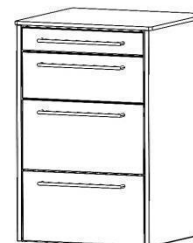

1VS-1S-2M

4 Drawers

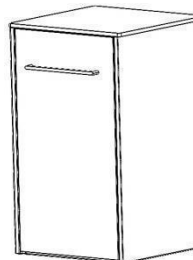

DOOR ONLY

1 DOOR

Can be used for Washbasin on top and Storage in cabinet

Contact Us

Technodent Exim India (P) Ltd. - TEiDental
B138, Ground Floor - Mohammadpur,
Near Bhikaji Cama Place, New Delhi-110066
CIN: U51507DL1996PTC079234

+91-11-4155 0193

+91 99102 11888

support@teidental.com